

# 2KW TV UHF SOLID STATE TRANSMITTER MOD. STU 32

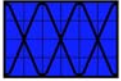



## GENERAL DESCRIPTION

The **STU 32** is a solid state LDMOS 2 KW transmitter for TV broadcasting with combined amplification process in the UHF band IV and V, from 470 to 860 MHz. The equipment is fully compliant with the personnel safety requirements as specified in IEC 215. The rack frame design is very suitable for an easy maintenance and service: each unit can be easily removed and checked.

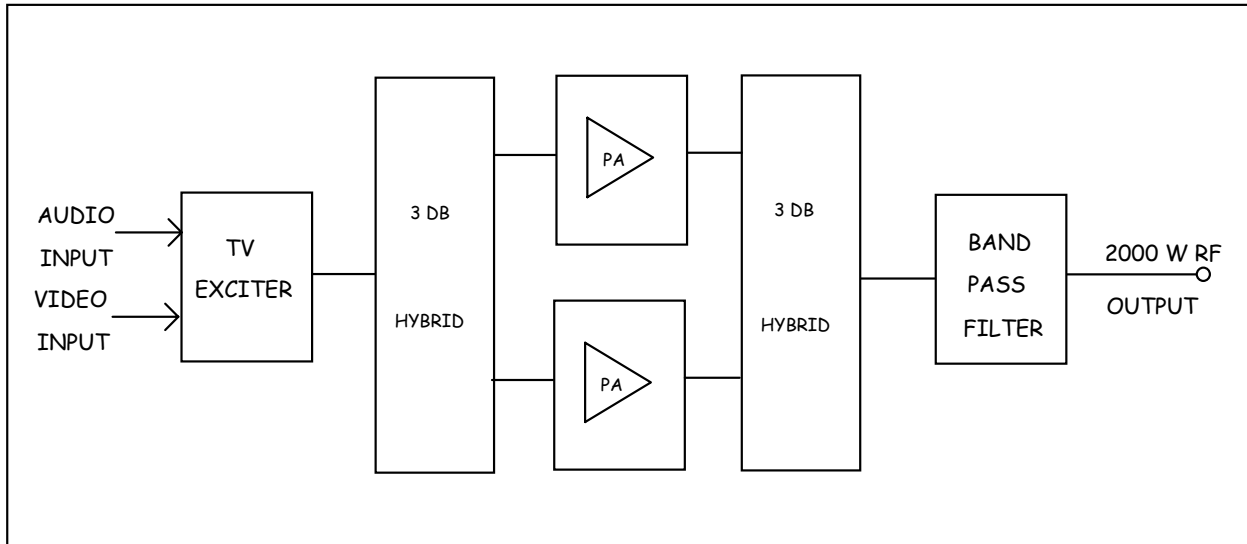

**STU 32 - Simplified Block Diagram**

## EXCITER

The **EXCITER** stage is very flexible due to his modular plug-in design, enable combined and split amplification process as well as adaptation to the various TV standards. All routine on-air adjustment are made by commands from the front panel.

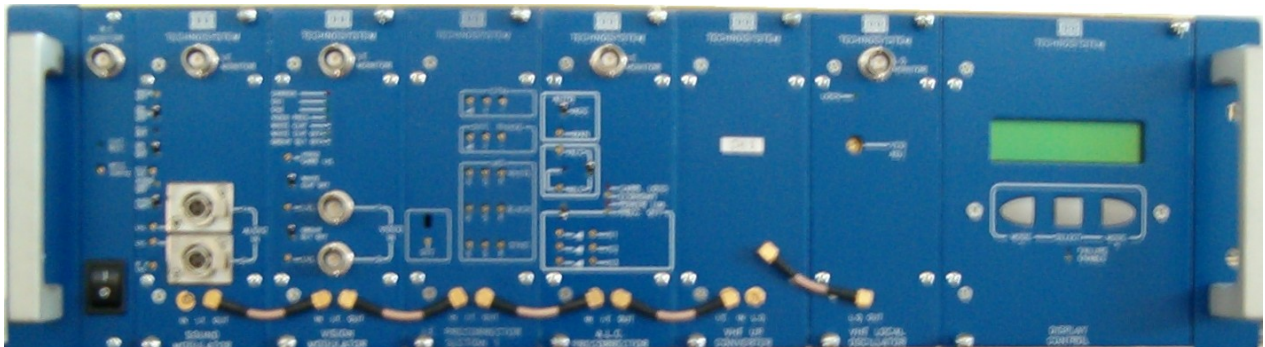

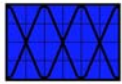

## POWER AMPLIFIER

**The amplification** is made up by two RF PA's (power amplifiers, SAU - 31), the nominal output power of each PA is 1 KW p.s. Each power amplifier employs solid state LD-MOS technology, 4 RF pallets and a driver, in order to obtain wide band, reliability, and high efficiency. The ventilation is assured by means of two high efficiency and high MTBF ventilators; the power supply of the final RF modules has been developed by means of switching power supplies directed by the network, one for each RF module, to obtain maximum redundancy, self-protected against overcurrent, overvoltage and overtemperature, while pilot RF is powered by the same power supplies in parallel (OR). This solution allows for "soft degradation", that is the reduction of output power in case of malfunctioning of wither an RF module or ofr a power supply. The heat sync has been designed to obtain very high efficiency levels that allow the amplifiers to function in the most severe of weather conditions.

The PA has a built-in switch-mode power supply unit self-protected against overcurrent and overvoltage , as well the overtemperature , overdrive and VSWR for RF parameters.



## COOLING SYSTEM

Each amplifier is air cooled with forced ventilation performed by two built-in high reliability blowers. A careful and proper design has been adopted in order to guarantee all the power devices to work safely even in very high temperature environments.

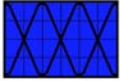

## RF

- Frequency range.....	470 to 860 MHz
- Output power.....	2000 W peak sync
- Vision/Sound power ratio.....	10/1 single sound or 20/1/0.2 dual sound
- Output-stage technology.....	solid state LD MOS
- Vision-Sound amplification.....	combined
- Standards.....	all standards
- Modulation class.....	C3F, F3E
- Sound transmission.....	FM single-sound ( IRT or NICAM 728 )
- Harmonic and spurious emission....	$\leq 1$ mW
- IMD products in band	$\leq 60$ dB
- Frequency stability.....	$\pm 100$ Hz / 1 month $\pm 1$ Hz / month
- External reference frequency.....	5 MHz, 0.2 $\div$ 1.0 V / 50 $\Omega$
- Offset capability.....	10/25 Hz steps up to $\pm 25$ kHz

## TRANSMISSION CHARACTERISTICS

- Sideband spectrum response.....	according to the standard
- Amplitude-frequency response.....	according to the standard
- Group delay variation .....	$\leq \pm 35$ ns (without receiver precorrection and sound trap in TV demod.)
- Non linearity distortion..... (mod. 10 to 75%)	$\leq 5\%$
- Differential gain..... (mod. 10 to 75%)	$\leq 5\%$
- Differential phase..... (mod. 10 to 75%)	$\leq \pm 2$ degrees
- Incidental carrier phase..... modulation	$\pm 3$ degrees
- Signal to hum (peak value) ratio..... (f < 10 kHz)	$\geq -48$ dB
- Signal to random noise..... (unweighted 0.2 to 5 MHz)	$\geq -56$ dB
- Blanking level variation.....	$\leq 2\%$
- 2T k factor.....	$\leq 2\%$
- ICPM (picture range).....	$\leq 2$ degrees
- Intercarrier S/N ratio.....	$\geq 46$ dB (referred to $\pm 50$ kHz deviation)

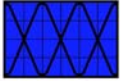

## VISION

- Video input..... 2 with aut. Switchover (BNC conn. 75  $\Omega$ )
- Colour systems..... PAL / SECAM / NTSC
- Nominal input level..... 1 Vpp  $\pm$  6dB into 75  $\Omega$
- Return loss.....  $\geq$  34 dB
- DC restoration..... clamped to the blanking level without affecting the burst
- White limiter..... at 90% picture signal without affecting the chrominance

## SOUND

- Sound input..... 2 with autom. Switchover (video master)
- Nominal input level..... +6 dBm  $\pm$  6dB ( $\pm$  50kHz dev.)
- Input impedance..... 600  $\Omega$  balanced
- Pre-emphasis..... 50  $\mu$ s (75  $\mu$ s on request)

## METERING

- Peak sync output power
- Reflected power
- Power supply status
- Temperature

## PROTECTION CIRCUITS

- VSWR
- Over-temperature
- Over-current

## REMOTE CONTROL

- Parallel interface..... start, stop, alarm, interlock
- Serial interface..... RS 232

## GENERAL

- Mains voltage..... 115/230 V AC +10% -15% single phase

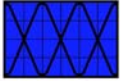

	<b>380/415 V AC +10% -15% three phase</b> <i>Others mains voltage available on request</i>
- Mains frequency.....	<b>47/63 Hz</b>
- Temperature range.....	<b>0 to +45°C</b>
- Relative humidity.....	<b>95% not condensing</b>
- Altitude.....	<b>up to 2.500 meters</b> <i>Higher altitude levels are possible on request</i>
- Power consumption (Black level).....	<b>4300 W</b>
- Power factor.....	<b>≥ 0.9 (TYPICAL ≥ 0.95)</b>
- Ambient dissipation.....	<b>&lt; 300 W</b>
- Air cooling.....	<b>1200 m<sup>3</sup>/h</b>
<b>Dimensions:</b>	
- Width.....	<b>590 mm</b>
- Height.....	<b>1300 mm</b>
- Depth.....	<b>1200 mm</b>
<b>Weight:.....</b>	<b>185 Kg.</b>

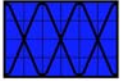

## STANDARD INSTALLATION REQUIREMENTS

### TRANSMITTER ROOM

The building floor must be suitable to support a capacity :

$\geq 300 \text{ kg / m}^2$

### INSTALLATION AREA

It must be clean and free of dust , the transmitter must be installed to have space around enough for ventilation and for maintenance actions to be allowed.

The minimum requirement space for transmitter must be :

2 x 2 x 2 (H) meter

### TEMPERATURE

Room temperature does not exceed :

0 to + 45 °C

### ELECTRICAL PLANT

The main power installed must be :

$\geq 8 \text{ kVA}$

### MAIN VOLTAGE

The single-phase AC voltage must be :

Nominal value + 10 to -15 %

### MAIN POWER CABLE SIZE (mm<sup>2</sup>)

Operation voltage	Phase wires	Neutral wire	Protection earth wire
220 V	$\geq 12$	not used	$\geq 16$

### AIR COOLING

The room must be capable of :

1200 m<sup>3</sup>/ h air flow

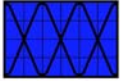

### Single Drive

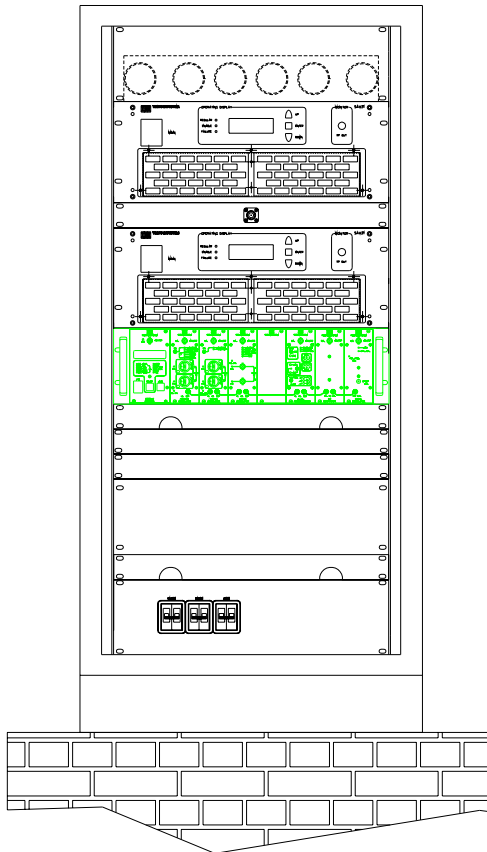

### Dual Drive

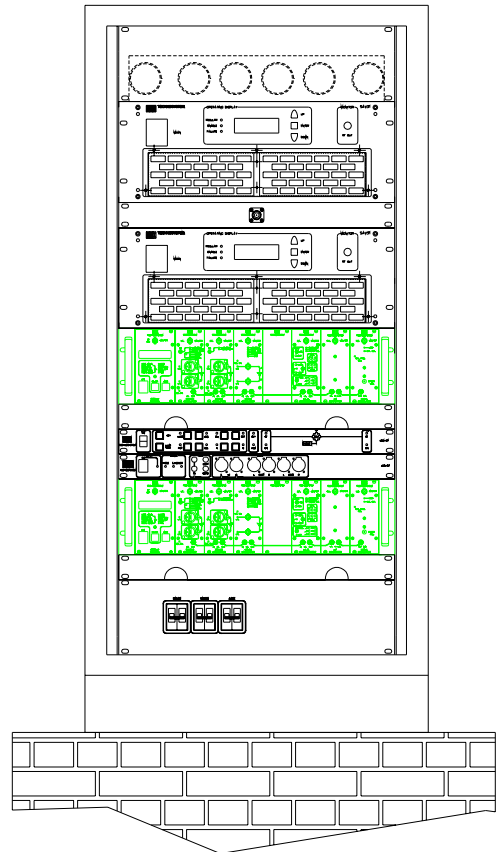

### Front View