

8807 Power Tube

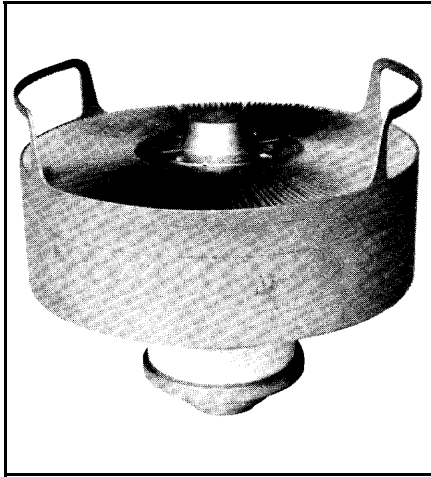

Beam Power Tube

CERMOLOX® Beam Power Tube
Full Input to 400 MHz
Forced-Air-Cooled

Single Sideband
15 kW PEP
20 dB Gain

17.6 kW Peak Sync Output
VHF-TV Band
13 dB Gain

FM Broadcast Service
20 kW Output
20 dB Gain

The BURLE-8807 is designed specifically for use in high gain, high linearity equipments for VHF-TV and FM service.

In VHF-TV service at 220 MHz, the 8807 will deliver a full 17.6 kW peak sync output with 6.3 MHz bandwidth and 13 dB gain. In FM broadcast service, the 8807 will deliver 20 kilowatts with a gain of 20 dB.

Rated for full input to 400 MHz, the 8807 is easily circuited to this frequency. The terminals are coaxial for operation in the TEM mode and the radiator location avoids restricting the resonant cavity circuits in VHF operation. The 8807 assures high gain-bandwidth products for the full VHF-TV band.

Its sturdy, coaxial CERMOLOX tube construction and thoriated-tungsten mesh filament minimize tube inductances and feed-thru capacitances. They make possible the use of simple, economical, broadband circuit techniques in VHF operation.

This data sheet gives application information unique to the BURLE-8807. It is to be used in conjunction with the publication, "Application Guide for BURLE Power Tubes", TP-105, for general application information for tubes of this type.

Additional information of a general nature applicable to tubes of this type is given in the following publications:

- TP-122 Screen-Grid Current, Loading and Bleeder Considerations
- TP-117 Handling and Operating Considerations when Using BURLE Tetrodes
- TP-118 Application Guide for Forced Air Cooling BURLE Power Tubes

Close attention to the instructions contained in these publications will assure longer tube life, safer operation, less equipment downtime and fewer tube handling accidents. For copies of these publications, specific information or application assistance, contact your nearest BURLE Representative or write BURLE INDUSTRIES, INC., 1000 New Holland Ave., Lancaster, PA 17601-5688.

General Data

Electrical

All voltages referenced to cathode, unless otherwise specified.

Filamentary Cathode, Thoriated-Tungsten Mesh Type:

Voltage ¹ (ac or dc)	9.5	typ.	V
	10.0	max.	V

Caution: For long-life expectancy, the filament voltage must be adjusted initially and throughout life as described in the procedure under "Operating Considerations"; "Filament Voltage Adjustment".

Current:

Typical value at 9.0 volts² 140 A

Maximum value for starting, even, momentarily³ 300 A

Cold resistance 0.01 ohm

Recommended heating time⁴ 2 to 15 min.

Mu-Factor⁵, (Grid No.2 to grid No.1) 12

Direct Interelectrode Capacitances:

Grid No.1 to plate⁶ 0.36 max. pF

Grid No.1 to filament 85 pF

Plate to filament⁶ 0.09 max. pF

Grid No.1 to grid No.2 75 pF

Grid No.2 to plate 18 pF

Grid No.2 to filament⁷ 3.5 max. pF

General Data (cont'd)

Mechanical

Operating Attitude	Vertical, either end up
Overall Length (Max.)	170.18 mm (6.700 in)
Greatest Diameter	180.59 mm (7.110 in)
Socket	CD89-085 ⁸ or equivalent
Chimney	8824 ⁸ or equivalent
Radiator	Integral part of tube
Weight (approx.)	5.5 kg (12 lbs)

Thermal

Seal Temperature ⁹	250 max. °C
(Plate, Grid No.2, Grid No.1, Cathode-Filament, and Filament)	
Plate-Core Temperature ^{9, 10}	250 max. °C

Characteristic Range Values

Parameter	Min.	Max.	Units
Filament Current ¹¹	135	160	A
Direct Interelectrode Capacities:			
G ₁ to plate ⁶	-	0.36	pF
G ₁ to filament	80	94	pF
Plate to filament ⁶	-	0.09	pF
G ₁ to G ₂	72	82	pF
G ₂ to plate	17.0	19.0	pF
G ₂ to filament ⁷	-	3.5	pF
Zero-Bias Plate Current ^{11, 12}	11.0	-	A
Grid No. 1 Voltage ^{11, 13}	100	160	V

RF Power Amplifier & Osc. - Class AB Telephony¹⁴ and RF Power Amplifier - Class AB FM Telephony

Maximum CCS Ratings, Absolute-Maximum Values¹⁵

Up to 400 MHz		
DC Plate Voltage ¹⁶	10,000	V
DC Grid-No.2 Voltage ¹⁷	1650	V
DC Grid-No.1 Voltage ¹⁸	-500	V
DC Plate Current	5.0	A
DC Grid-No.1 Current	300	mA
Grid-No.1 Input	150	W
Grid-No. 2 Input	250	W
Plate Dissipation ^{19, 10}	15.0	kW
Loaded Q	30	

Maximum Circuit Values

Grid-No.1-Circuit Resistance Under Any Conditions:	
With fixed bias	1000 ohms
With cathode bias	Not recommended

Typical, Grid Driven, Class AB, CCS Operation

At 7.0 MHz		
DC Plate Voltage	7500	V
DC Grid-No.2 Voltage	1000	V
DC Grid-No.1 Voltage ²⁰	-145	V
Zero-Signal DC Plate Current	500	mA
DC Plate Current	3.7	A
DC Grid-No.2 Current	115	mA
DC Grid-No.1 Current	250	mA
Driver Power Output (Approx.) ²¹	125	W
Grid Loading Resistance	1000	ohms
Output-Circuit Efficiency ¹⁴ (Approx.)	95	%
Useful Power Output	20	kW

Calculated CCS Operation

In a Grid-Drive Circuit at 108 MHz		
DC Plate Voltage	7500	V
DC Grid-No.2 Voltage	1000	V
DC Grid-No.1 Voltage ²⁰	-145	V
Zero-Signal DC Plate Current	500	mA

DC Plate Current	3.7	A
DC Grid-No.2 Current	115	mA
DC Grid-No.1 Current	250	mA
Driver Power Output (Approx.) ²¹	200	W
Output Circuit Efficiency ¹⁴	95	%
Useful Power Output	20	kW

RF Power Amplifier-Class B Television Service¹⁴

Synchronizing-level conditions per tube unless otherwise specified.

Maximum CCS Ratings, Absolute-Maximum Values

DC Plate Voltage ¹⁶	10,000	V
DC Grid-No.2 Voltage ¹⁷	1650	V
DC Grid-No.1 Voltage ¹⁸	-600	V
DC Plate Current	6	A
Plate Dissipation ^{19, 10}	15,000	W
Grid-No.2 Input	250	W
Grid-No.1 Input	150	W

Typical CCS Operation

In a cathode-drive circuit at 216 MHz and bandwidth of 6.3 MHz²²

DC Plate Voltage	7500	V
DC Grid-No.2 Voltage	1500	V
DC Grid-No.1 Voltage ²⁰	-220	V
Zero-Signal DC Plate Current	500	mA
DC Plate Current:		
Synchronizing level	4.40	A
Blanking level	3.30	A
DC Grid-No.2 Current:		
Synchronizing level	62	mA
Blanking level	45	mA
DC Grid-No.1 Current:		
Synchronizing level	70	mA
Blanking level	55	mA
Driver Power Output: ²¹		
Synchronizing level	770	W
Blanking level	435	W
Output Circuit Efficiency (Approx.)	90	%
Useful Power Output:		
Synchronizing level	17,600	W
Blanking level	9850	W
Typical Linearity ²³ , at 8kW (Approx.)	-52	dB
Power Gain, Including Circuit Losses	13	dB

Linear RF Power Amplifier,¹⁴

Class AB or Class B Telephony

Carrier conditions for use with a maximum modulation factor of 1.0.

Maximum CCS Ratings, Absolute-Maximum Values

DC Plate Voltage ¹⁶	10,000	V
DC Grid-No.2 Voltage ¹⁷	1650	V
DC Plate Current	3	A
Grid-No.2 Input	300	W
Plate Dissipation ^{19, 10}	15,000	W
Loaded Q	30	

Typical Class CCS Operation as a Class B TV Aural Amplifier

In a cathode drive circuit at 216 MHz

DC Plate Voltage	7000	7500	V
DC Grid-No.2 Voltage	1000	1000	V
DC Grid-No.1 Voltage	-145	-145	V
Zero-Signal DC Plate Current	500	500	mA
DC Plate Current	1.92	2.72	A
DC Grid-No.2 Current	10	60	mA
DC Grid-No.1 Current	5	25	mA
Driver Power Output ²¹	230	380	W
Output Circuit Efficiency ¹⁴ (Approx.)	90	90	%
Useful Power Output	6500	12,000	W

1. Measured at the tube terminals, For accurate data the ac filament voltage should be measured using an accurate RMS type meter such as the iron-vane or the thermocouple type meter. The dc voltage should be measured using a high input impedance type meter.

For high-current, low-voltage filaments such as are used in the 8807, it is recommended that the filament current be monitored since very small changes in resistance can produce misleading changes in voltage. For maximum life, the filament power should be regulated at the lowest value that will give stable performance. For those applications where hum is a critical consideration, dc filament or hum-bucking circuits are recommended. See also Application Note TP-117.

2. It is recommended that an additional seven amperes be available to allow for the normal reduction of filament resistance with life. Thus the filament supply adjustment should be designed for a capability of 167 amperes at 95 volts. A minimum setting is 8.85 volts.
3. To limit filament surge current, a series resistor is recommended: the resistor can then be shorted after 15 seconds.
4. Recommended standard procedure for maximum stability and longest life. Heating time may be shortened under special circumstances if the following precautions are observed:
 - a Filament heating time of 15 to 90 seconds followed by grid-No.1, plate, grid-No.2, and RF drive.
 - b Emergency filament heating time of 4 seconds followed by grid-No.1, plate, grid-No.2, and RF drive. In addition, grid-No.1 voltage and RF drive must be changed proportionally to reduce plate current to 75% of its normal value for the first 15 seconds to prevent tripping plate overcurrent devices.
5. For plate voltage = 2000 V, grid-No.2 voltage = 1250 V, and plate current = 14 A.
6. With external flat metal shield 200 mm (8-inches) in diameter having a center hole 76 mm (3-inches) in diameter. Shield is located in plane of the grid-No.2 terminal, perpendicular to the tube axis, and is connected to grid. No.2.
7. With external flat metal shield 200 mm (8-inches) in diameter having a center hole 60 mm (2-3/8-inches) in diameter. Shield is located in plane of the grid-No.1 terminal, perpendicular to the tube axis, and is connected to grid No.1.
8. As manufactured by:
Jettron Products Inc., 56 Route Ten, Hanover, NJ 07936
9. See Dimensional Outline for Temperature Measurement Points. For good contact-finger life, a maximum temperature of 180°C at the terminal is recommended when using commercially-available beryllium-copper socket contacts.
10. The value of 250 °C is the average of three readings taken 120° apart around the anode core. **No one reading may exceed 300°C.**
11. With 9.5 VAC applied to the filament.
12. With dc-plate voltage = 2,000 V, dc grid-No.2 voltage = 1,500 V, and grid-No.1 voltage pulsed to zero V.
13. With dc plate voltage = 8000 V, dc grid-No.2 voltage = 1000 V, and the dc grid-No.1 voltage adjusted for a dc plate current = 0.5 A.
14. See TP-105. At the 3 dB points, the maximum recommended Q is 30.
15. In accordance with the Absolute Maximum rating system as defined by the Electronic Industries Association Standard RS-239A, formulated by the JEDEC Electron Tube Council.
16. See TP-105.

The maximum voltage ratings must be modified for operation at altitudes higher than sea level and for temperatures in excess of 20 °C in accordance with the curves of Figure 1. For altitude derating of the plate voltage, use the voltage difference between plate and grid No.2.

The maximum fault energy that can be dissipated within the tube is approximately 100 joules. Therefore, the energy available for a high-voltage arc or fault must be limited to this value by means of current limiting resistors or fault-protection circuitry such as spark gaps and electronic "crow bars". This is especially important

where high, stored energy and large capacitors are used. In typical 15 kW TV transmitters, the series resistors used are:

Plate - Thirty ohm minimum is required in high capacitance power supplies for video service.

Grid No.2 - Fifty ohms minimum.

Grid No.1 - Fifty ohms.

For additional information see TP-105, "Application Guide for BURLE Large Power Tubes".

17. See TP-105 and TP-122. Protection devices such as spark gaps should be used.
18. See TP-105. Protection devices such as spark gaps or positive clamping diodes should be used.
19. Permitted plate dissipation is a function of cooling. For specific ratings see Forced Air Cooling information in this data sheet.
20. Adjusted for specified zero-signal dc plate current.
21. Driver power output represents circuit losses in the driver output circuit and the grid input circuit in addition to the power necessary to drive the tube.
22. The bandwidth of 6.3 MHz is calculated at the -0.72 dB power points of a doubled-tuned output circuit using two times the tube output capacity and a damping factor of $\sqrt{1.5}$ as illustrated in Figure 2.
23. Third order IM with three-tone input signal which includes the aural carrier at -10 dB, the color sub-carrier at -17 dB and the visual carrier at -8 dB below the reference peak power level.

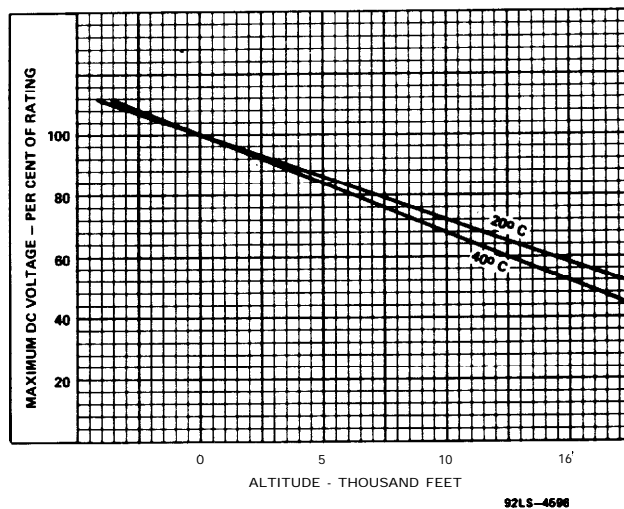

Figure 1 - Maximum DC Voltage with Respect to Altitude

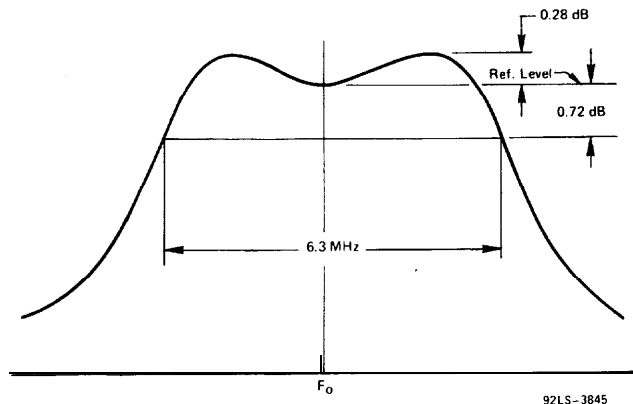

Figure 2 - Bandwidth Characteristics

Operating Considerations

Safety Precautions

Protection circuits serve a threefold purpose: safety of personnel, protection of the tube in the event of abnormal circuit operation, and protection of the tube circuits in the event of abnormal tube operation.

Power tubes require mechanical protective devices such as interlocks, relays, and circuit breakers. Circuit breakers alone may not provide adequate protection in certain power-tube circuits when the power-supply filter, modulator, or pulse-forming network stores much energy. Additional protection may be achieved by the use of high-speed electronic circuits to bypass the fault current until mechanical circuit breakers are opened. These circuits may employ a controlled gas tube, such as a thyratron or ignitron, depending on the amount of energy to be handled.

Great care should be taken during the adjustment of circuits. The tube and its associated apparatus, especially all parts which may be at high potential above ground, should be housed in a protective enclosure. The protective housing should be de-

signed with interlocks so that personnel can not possibly come in contact with any high-potential point in the electrical system. The interlock devices should function to break the primary circuit of the high-voltage supplies and discharge high-voltage capacitors when any gate or door on the protective housing is opened, and should prevent the closing of this primary circuit until the door is again locked.

The screen circuit requires special attention because the heating power of the current and voltage on this electrode is not the algebraic product of the current and voltage elements as observed at the terminal. For analysis of the circuit, review TP-122.

A time-delay relay should be provided in the grid-No.1 supply circuit to delay application of this voltage until the filament has reached normal operating temperature.

An interlocking relay system should be provided to prevent application of plate voltage prior to the application of sufficient bias otherwise, with insufficient bias, the resultant high plate current may cause excessive plate dissipation with consequent damage to the tube. RF load shorts or other causes of high output VSWR may also cause high dissipations, excessive

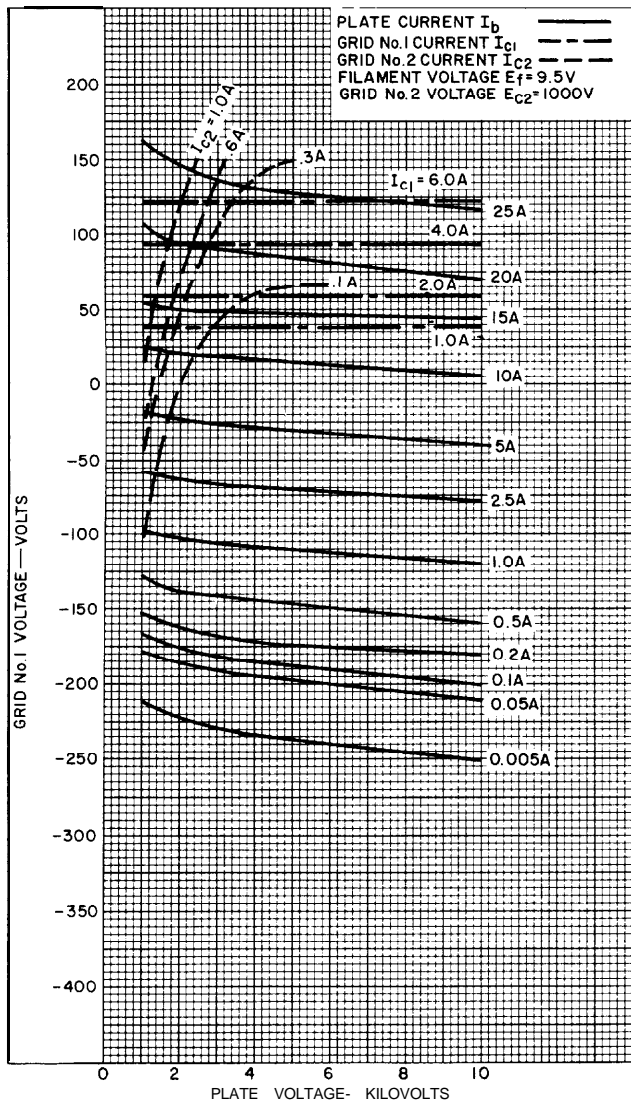

Figure 3 - Typical Constant Current Characteristics

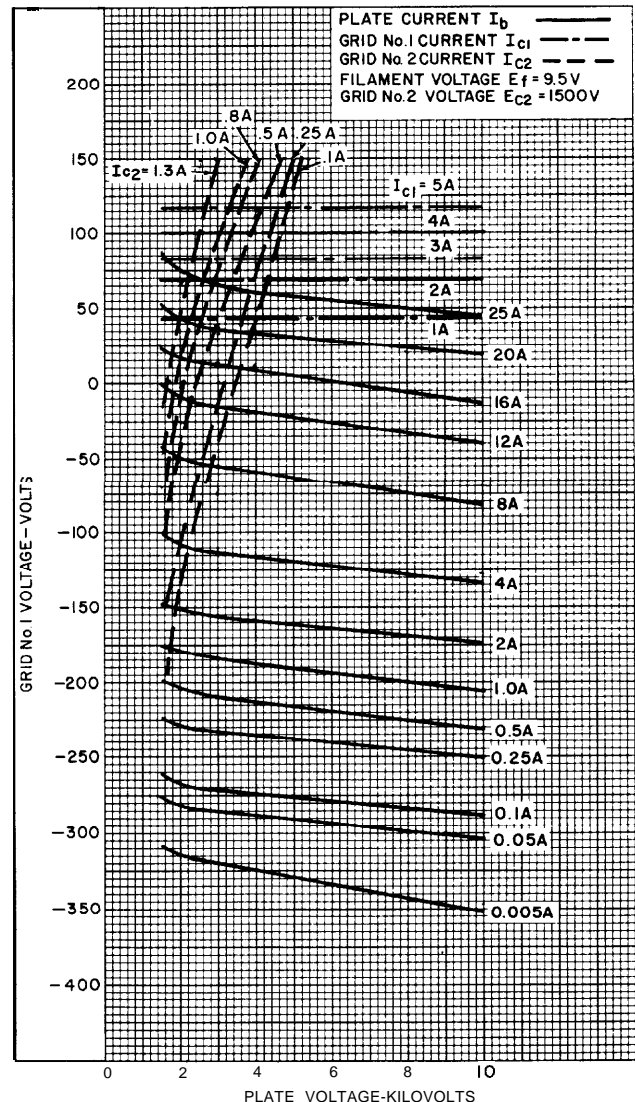

Figure 4 - Typical Constant Current Characteristics

voltage gradients, or insulator flashover. The load VSWR should be monitored and the detected signal used to actuate the interlock system to remove the plate voltage in less than 10 milliseconds after the fault occurs.

Filament-Voltage Adjustment

The life of the filament can be conserved by adjusting to the lowest filament supply voltage that will give the desired performance. Follow the filament voltage adjustment procedure below.

Regulated Filament Supplies:

1. Before the application of any other voltages to a new tube, the filament voltage should be adjusted to 9.5 volts at the tube socket. A true RMS voltmeter should be used for accurate measurement. It may be more convenient to make the measurement at other contacts in the equipment, but the value will be higher because of increased impedance such as wire loss or contact resistance.
2. Apply voltages and adjust tuning controls as necessary for proper operation as described in the appropriate instruction manual.
3. Reduce the filament voltage in 0.1 -volt increments -- repeating the procedures in Steps 1 and 2 --until performance degradation is noted. Then increase the heater voltage 0.1 volt above this point. Typically depending upon the application, this voltage will be in the range of 9.0 to 9.3 volts.

Unregulated Filament Supplies:

1. If an unregulated filament supply is used, the above procedure for regulated supplies should be performed during low-line conditions to assure adequate tube performance during these periods. Then check during high-line conditions to assure that the 10.0 volt maximum is not exceeded.

During life when evidence is observed that a tube is becoming emission limited, increasing the filament voltage may extend the useful life of the tube. However, never increase filament voltage to compensate for a decrease in other circuit parameters such as RF drive or video modulating voltage!

Forced Air Cooling

Cooling air flow is necessary to limit the anode-core and terminal-seal temperatures to values that will assure long reliable life. A sufficient quantity of air should be directed past each of these terminals so that its temperature does not approach the absolute-maximum limit. The absolute-maximum temperature rating for this tube is 250 °C. It is recommended that a safety factor of 25° to 50° be applied, to compensate for all probable system and component variations throughout life.

The cooling air must be delivered by the blower through the radiator and at the terminal seals during the application of power and for a minimum of three minutes after the power has been removed.

To Cathode-Filament and Filament Terminals -- A sufficient quantity of air should be blown directly at these terminals so that their temperature does not approach the absolute-maximum limit of 250 °C. A value of at least 60 cfm is recommended.

The Cooling Characteristic Curve, **Figure 5**, indicates the air flow and pressure requirements of a system sufficient to limit the core temperature to specific values for various levels of plate dissipation.

Because the cooling capacity of air varies with its density, factors must be applied to the air flow to compensate for operation at altitude or in high temperature environments.

During Standby Operation -- Cooling air is required when only the filament voltage is applied to the tube.

For further information on forced air cooling, see TP-105 and also TP-118, "Application Guide for Forced Air Cooling of BURLE Power Tubes."

Mounting

See the preferred mounting arrangement shown in **Figure 7**. For other arrangements, cavity-type mounting for multiple-ring terminal-type tubes may be constructed by using either fixed or adjustable contact rings of finger contact strips in the transverse plane.

Tube Removal from Socket (Suggested Method)

It is recommended that the tube be removed from the socket with an assembly similar to that shown in **Figure 10**. The extractor plate should be constructed as shown in **Figure 12**.

The tube should not be removed from the socket by rocking the tube back and forth. This motion crushes the contact fingers and applies undue force to the internal structure of the tube.

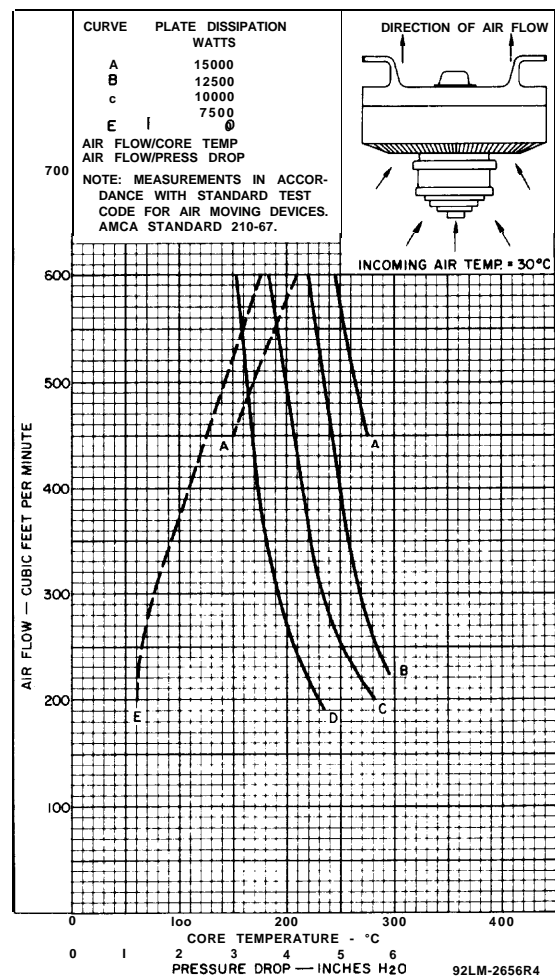
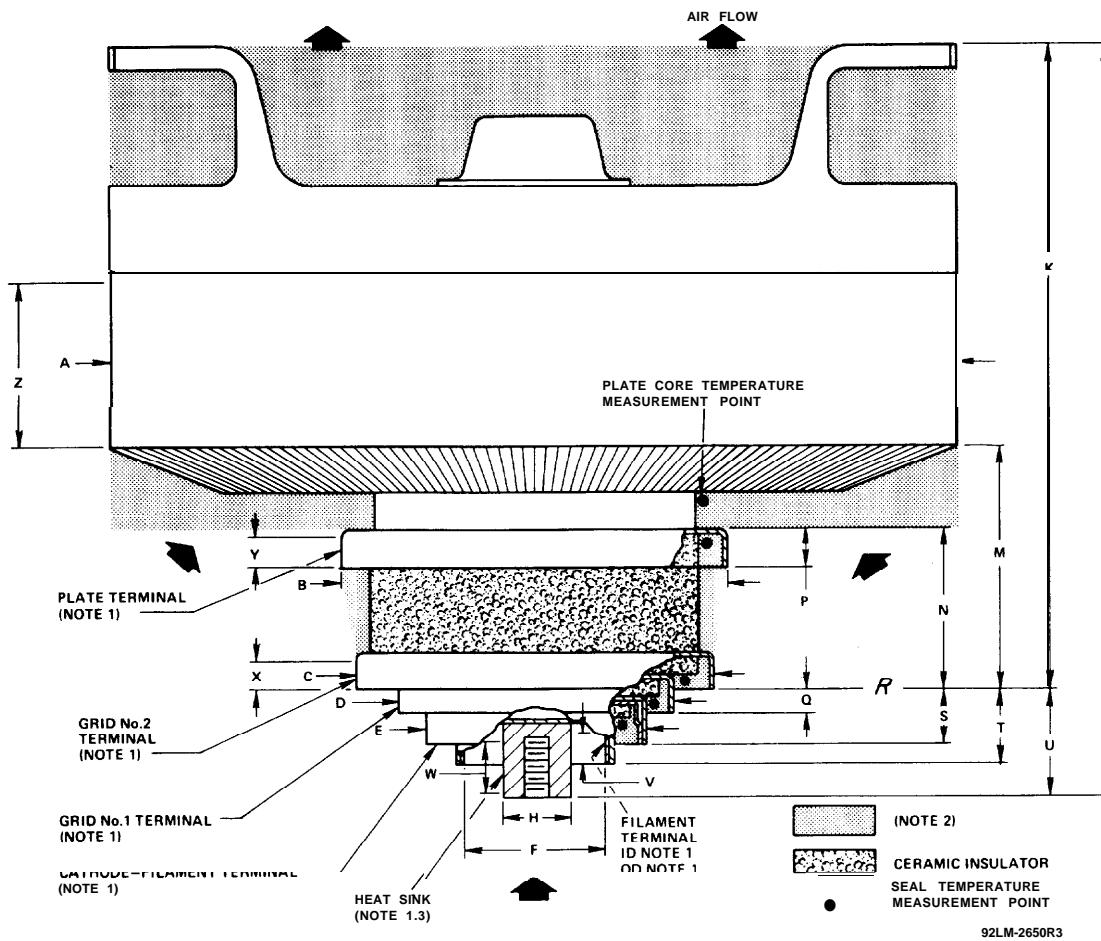

Figure 5 - Air Flow Characteristics



Tabulated Dimensions

Dimension	Millimeters	Inches	Note
A Dia.	179.20 ± .76	7.055 ± .030	1
B Dia.	82.30 ± .25	3.240 ± .010	1
C Dia.	76.91 ± .36	3.028 ± .014	1
D Dia.	58.90 ± .30	2.319 ± .012	1
E Dia.	46.99 ± .25	1.850 ± .010	1
F Dia.	30.48 ± .25	1.200 ± .010	1
H Dia.	15.67 ± .08	0.617 ± .003	1
J	170.18 max.	6.700 max.	
K	139.95 max.	5.655 max.	
M	50.80 ± 1.0	2.000 ± .040	
N	35.56 ± .8	1.400 ± .030	
P	8.26 ref.	0.325 ref.	
Q	5.08 ± .63	0.200 ± .025	
S	12.7 ± .8	0.50 ± .030	
T	18.42 ± 1.01	0.725 ± .040	
U	25.4 ± 1.3	1.00 ± .05	
V	6.35 min.	0.250 min.	
W	9.52 min.	0.375 min.	
X	5.59 min.	0.220 min.	
Y	4.06 min.	0.160 min.	
Z	31.80 min.	1.250 min.	

Note 1 - The diameter of each terminal is maintained only over the indicated minimum length of its contact surface.

Note 2 - Keep all stippled regions clear. In general, do not allow contacts to protrude into these annular regions. If special connectors are required which may intrude on these regions contact BURLE Power Tube Applications Engineering, Lancaster, PA.

Note 3 - Tapped 1/4-20 NC x 12.7 mm (0.5 inch) deep.

Note 4 - With the plate terminal and the cathode-filament terminals used as reference, the other terminals will measure less than 1.02 mm (0.040 inch) total indicator run-out (TIR).

Figure 6 - Dimensional Outline

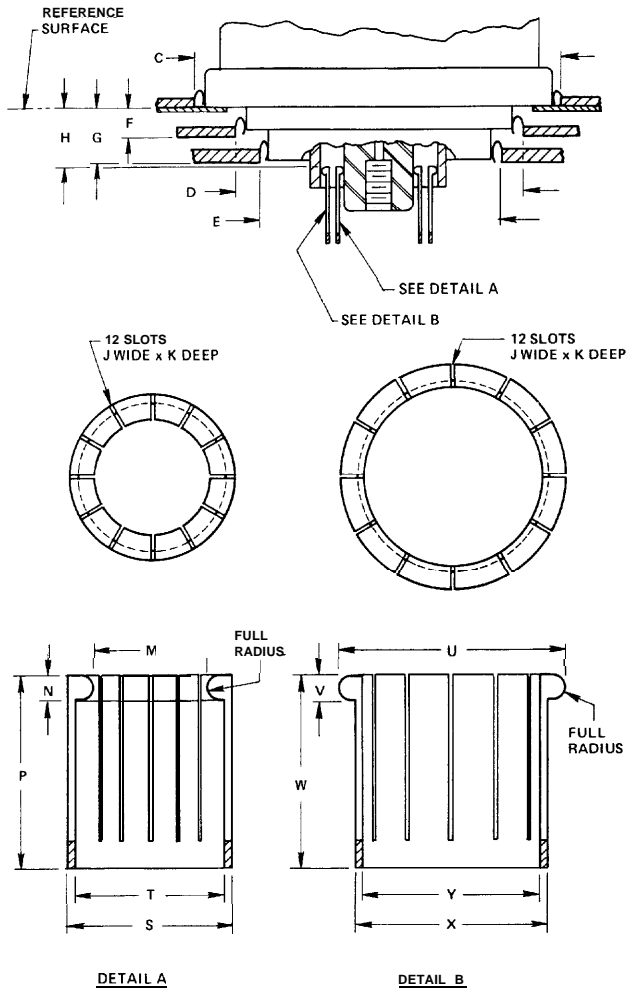

92LM-4550

Tabulated Dimensions

Dimension	Millimeters	Inches	Notes
C Dia.	81.79	3.220	Note 1
D Dia.	63.75	2.510	Note 1
E Dia.	51.82	2.040	Note 1
F	5.46	0.215	
G	10.92	0.430	
H	12.07	0.475	
J	0.38	0.015	
K	20.32	0.800	
M Dia.	15.24	0.600	Note 2
N	3.18	0.125	
P	25.40 min.	1.000 min.	
S Dia.	21.59	0.850	
T Dia.	19.43	0.765	
U Dia.	31.11	1.225	Note 3
V	3.18	0.125	
W	25.40 min.	1.000 min.	
X Dia.	26.92	1.060	
Y Dia.	24.77	0.975	

Figure 7 - Preferred Mounting Arrangement

Note 1 - The tolerance for the indicated dimension is:
plus 0.25 mm (0.010 inch)
minus 00 mm (00 inch)

Note 2 - The tolerance for the indicated dimension is:
plus 00 mm (00 inch)
minus 0.05 mm (0.002 inch)

Note 3 - The tolerance for the indicated dimension is:
plus 0.05 mm (0.002 inch)
minus 00 mm (00 inch)

Note 4 - Finger stock is No.97-135A, as made by:
Instrument Specialties Company
Little Falls, N.J. 07424

Note 5 - Sockets and chimneys are available and may be obtained in limited quantities from BURLE and in production quantities from: Jettron Products Inc., 56 Route Ten, Hanover, N.J. 07936

Supplier Socket No.
Jettron CD 89-085

Chimney No.
8824

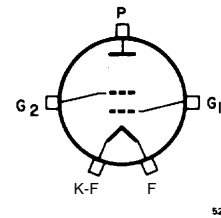

Figure 8 - Terminal Diagram

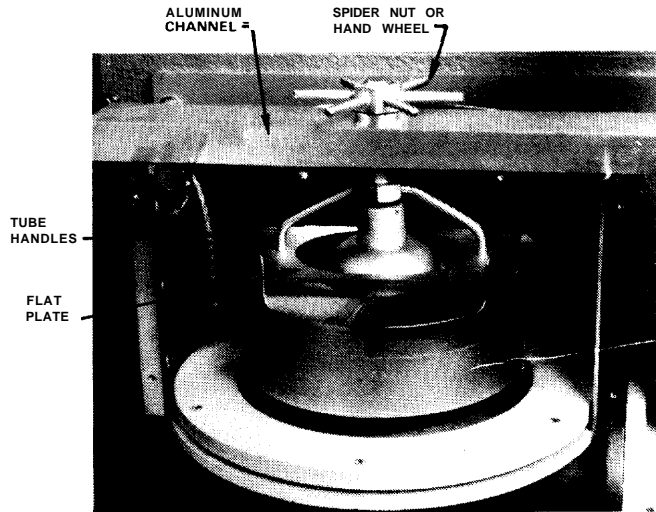
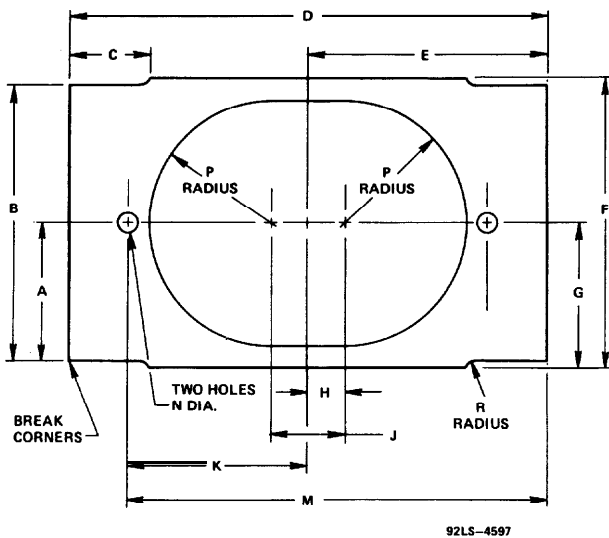

Figure 9 - BURLE Tube Type 8807 Being Removed



Tabulated Dimensions

Dimension	Millimetres	Inches
A	47.8	1.87
B	95.3	3.75
C	28.4	1.12
D	168.1	6.62
E	84.1	3.31
F	101.6	4.00
G	50.8	2.00
H	12.7	0.50
J	25.4	1.00
K	63.5	2.50
M	127.0	5.00
N Dia.	0.66	0.26
P Radius	41.1	1.62
R Radius	12.7	0.50

Figure 10 - Extractor Plate

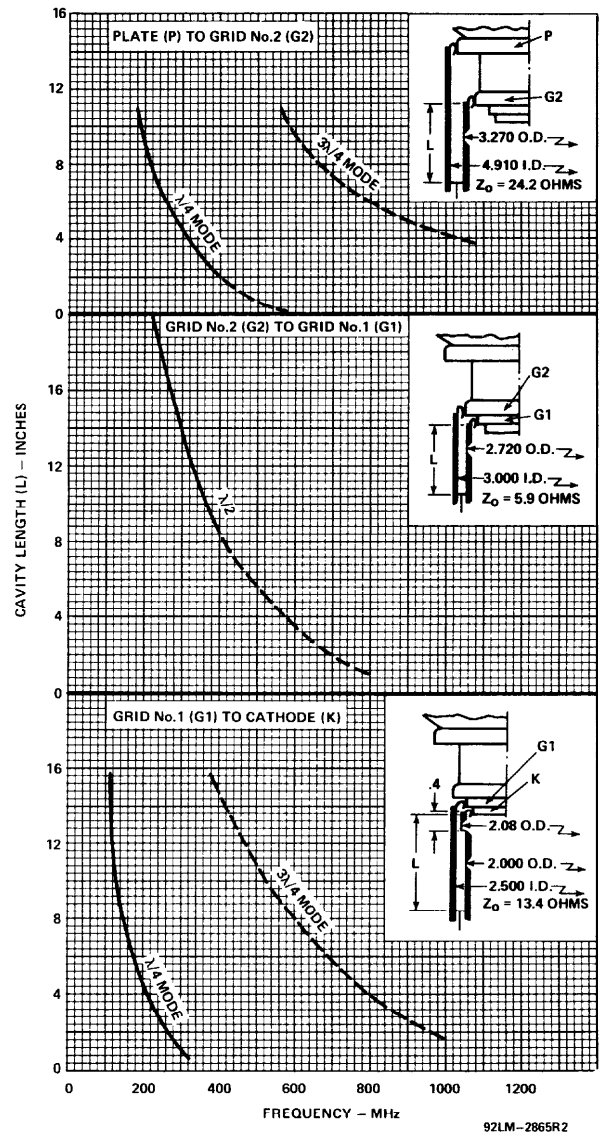

Maximum rated frequency is 400 MHz. Note solid line of tuning curves to 400 MHz. However, the tube is capable of amplification to beyond 2 GHz and care must be taken by the circuit designer to prevent parasitic oscillations at high frequencies. Dashed line of tuning curves above 400 MHz are provided for circuit design assistance to prevent oscillation in the TE_{11} mode.

Figure 11 - Electrode Cavity Tuning Characteristics

Warning - Personal Safety Hazards

Electrical Shock - Operating voltages applied to this device present a shock hazard.

RF Radiation - This device in operation produces RF radiation which may be harmful to personnel.

All specifications subject to change without notice. Information furnished by BURLE INDUSTRIES, INC. is believed to be accurate and reliable. However, no responsibility or liability is assumed by BURLE for its use, nor for any infringement of patents or other rights of third parties which may result from its use. No license is granted by implication or otherwise under any patent or other rights of BURLE INDUSTRIES, INC.

Copyright 1989 by BURLE TECHNOLOGIES, INC. All Rights Reserved.
 BURLE® and BURLE INDUSTRIES, INC.® are registered trademarks of BURLE TECHNOLOGIES, INC. Marca(s) Registrada(s).

BURLE INDUSTRIES, INC., Tube Products Division
 1000 New Holland Ave., Lancaster, PA 17601-5688 U.S.A

Printed in U.S.A / 6-89
 8807